

Powered by



# GPL 12400 ▶ 12V 40Ah

GPL 12400 is a general purpose battery up to 10 years in standby service or more than 260 cycles at 100% discharge in cycle service . As with all CSB batteries, all are rechargeable , highly efficient , leak proof and maintenance free.



## ► Specification

<b>Cells Per Unit</b>	6
<b>Voltage Per Unit</b>	12
<b>Capacity</b>	40 Ah @ 20hr-rate to 1.75V per cell @25 °C (77°F)
<b>Weight</b>	Approx. 14.5 kg(32.0 lbs)
<b>Maximum Discharge Current</b>	400A(5sec)
<b>Internal Resistance</b>	Approx. 7 mΩ
<b>Operating Temperature Range</b>	Discharge: -15°C~50°C ( 5°F~122°F) Charge: -15 °C~40°C ( 5°F~104°F) Storage: -15°C~40°C ( 5°F~104°F)
<b>Nominal Operating Temperature Range</b>	25°C±3°C (77°F±5°F)
<b>Float Charging Voltage</b>	13.5 to 13.8 VDC/unit Average at 25°C (77°F)
<b>Recommended Maximum Charging Current Limit</b>	12 A
<b>Equalization and Cycle Service</b>	14.4 to 15.0 VDC/unit Average at 25°C (77°F)
<b>Self Discharge</b>	CSB Batteries can be stored for more than 6 months at 25°C (77°F) . Please charge batteries before using . For higher temperatures the time interval will be shorter.
<b>Terminal</b>	B2-L terminal to accept M5 nut & bolt
<b>Container Material</b>	ABS(UL 94-HB/File E50263)*Flammability resistance of (UL 94-V0/File E88637) can be available upon request.



MH14533(N)



No.:041005117



CSB-manufactured batteries are UL-recognized components under UL924 and UL1989. CSB is also certified by ISO 9001 and ISO 14001.

## ► Dimensions :

Overall Height (H)	Container height (h)	Length (L)	Width (W)
Unit: mm (inch)	170±2 (6.69±0.08)	168.5±2 (6.63±0.08)	197±2 (7.76±0.08)

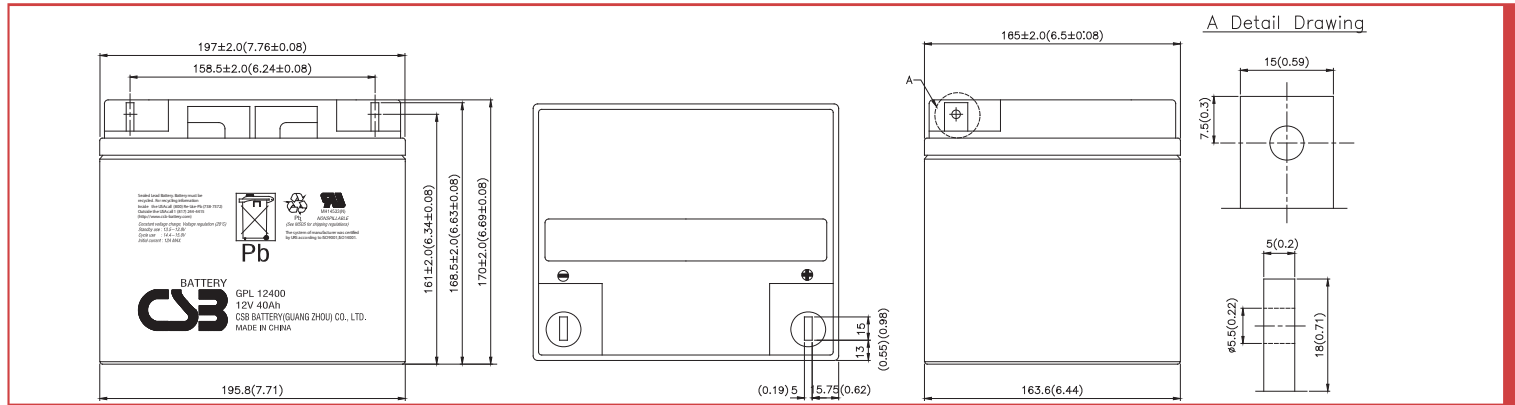

## Constant Current Discharge Characteristics Unit:A (25°C ,77°F)

F.V/Time	5MIN	10MIN	15MIN	30MIN	1HR	2HR	3HR	4HR	5HR	8HR	10HR	20HR
1.60V	162	104	78.2	47.7	28.1	16.3	11.6	9.04	7.37	4.83	3.94	2.03
1.67V	145	96.5	74.5	46.7	27.9	16.2	11.5	8.99	7.34	4.78	3.86	1.95
1.70V	137	92.8	72.4	46.1	27.8	16.1	11.4	8.97	7.33	4.76	3.83	1.91
1.75V	124	87.4	69.5	45.0	27.6	16.0	11.3	8.93	7.30	4.69	3.77	1.84
1.80V	111	81.3	65.9	43.8	27.4	15.9	11.2	8.90	7.26	4.63	3.71	1.78
1.85V	98.1	75.1	62.4	42.5	27.0	15.8	11.1	8.86	7.22	4.56	3.64	1.71

## Constant Power Discharge Characteristics Unit:W (25°C ,77°F)

F.V/Time	5MIN	10MIN	15MIN	30MIN	1HR	2HR	3HR	4HR	5HR	8HR	10HR	20HR
1.60V	1,941	1,242	938	572	338	195	139	109	88.4	58.0	47.2	24.4
1.67V	1,735	1,158	895	558	335	194	138	108	88.1	57.3	46.4	23.3
1.70V	1,647	1,117	869	552	334	193	137	107	87.9	57.0	46.0	22.9
1.75V	1,490	1,049	830	539	331	192	136	106	87.5	56.3	45.2	22.1
1.80V	1,334	975	791	525	328	191	135	105	87.2	55.6	44.4	21.3
1.85V	1,178	902	749	510	324	190	134	104	86.7	54.8	43.7	20.6

### Trickle (or Float) Service Life

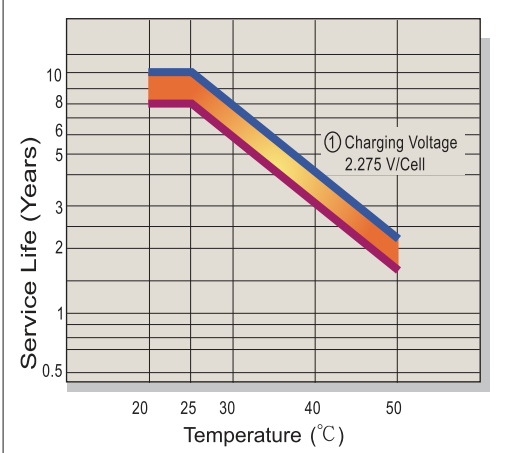

### Capacity Retention Characteristic

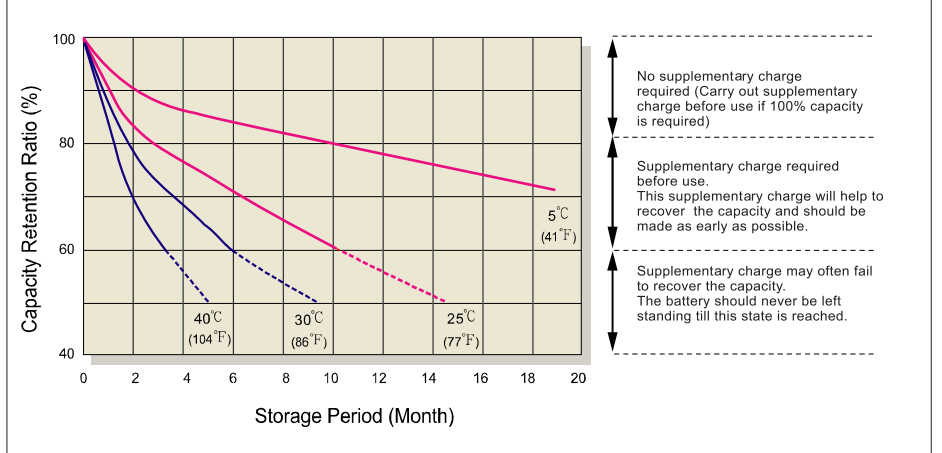

### Battery Voltage and Charge Time for Standby Use

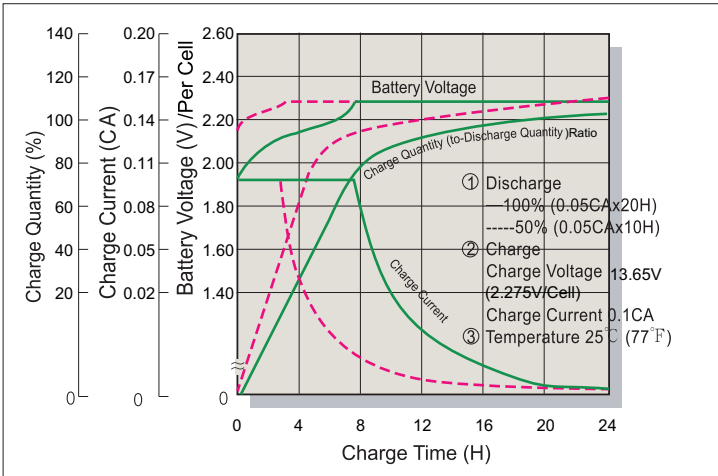

### Cycle Service Life

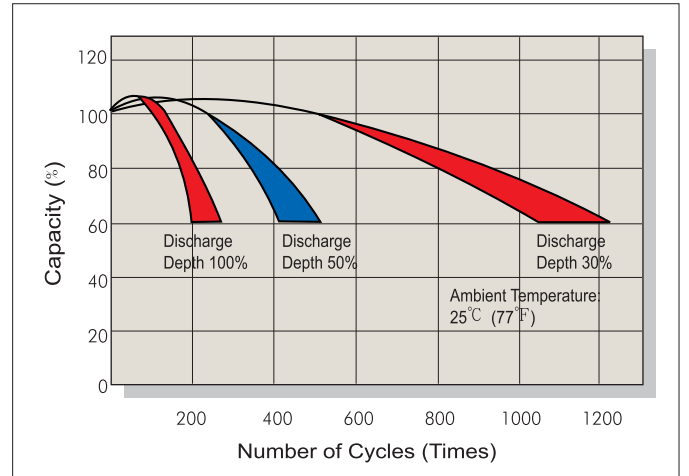

### Battery Voltage and Charge Time for Cycle Use

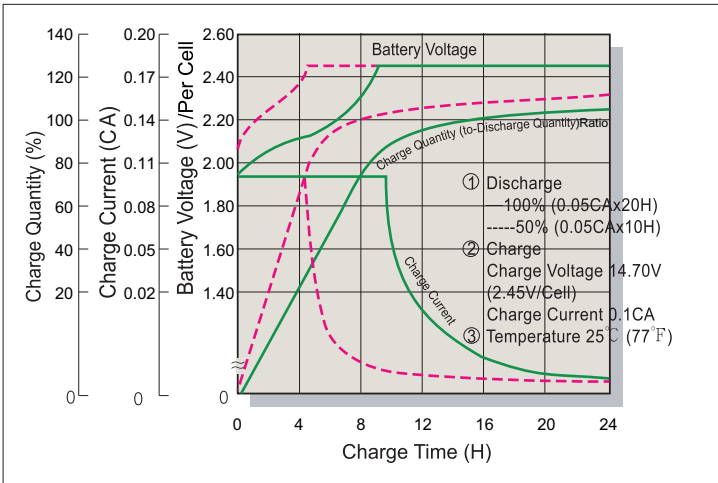

### Terminal Voltage (V) and Discharge Time

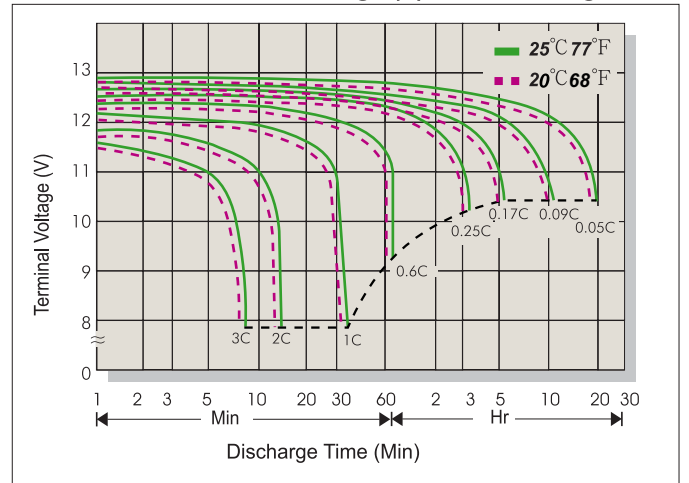

### Charging Procedures

Application	Charge Voltage(V/Cell)			Max.Charge Current
	Temperature	Set Point	Allowable Range	
Cycle Use	25°C(77°F)	2.45	2.40~2.50	0.3C
Standby	25°C(77°F)	2.275	2.25~2.30	

### Discharge Current VS. Discharge Voltage

Final Discharge Voltage V/Cell	1.75	1.70	1.60	1.30
Discharge Current(A)	0.2C>(A)	0.2C<(A)<0.5C	0.5C<(A)<1.0C	(A)>1.0C

Sales Office URL: [WWW.CSB-BATTERY.COM](http://WWW.CSB-BATTERY.COM)

**CSB BATTERY CO., LTD.**  
TAIWAN OFFICE  
Tel: +886-2-2555-5600  
Fax: +886-2-2555-3300  
E-mail: service@csb-battery.com.tw

**CSB BATTERY LOGISTICS (SHANGHAI) CO., LTD.**  
SHANGHAI OFFICE  
Tel: +86-21-5046-1622, 5046-0833  
Fax: +86-21-5064-3314  
E-mail: chinasl@csb-battery.com

**CSB BATTERY TECHNOLOGIES, INC**  
USA OFFICE  
Tel: +1-817-244-7777/1-8003 CSBUSA(272872)  
Fax: +1-817-244-4445  
E-mail: csb@csb-battery.com

**CSB BATTERY LOGISTICS (SHANGHAI) CO., LTD.**  
BEIJING OFFICE  
Tel: +86-10-6597-8060, 6597-8070  
Fax: +86-10-6597-8050  
E-mail: chinasl@csb-battery.com

**CSB BATTERY OF NETHERLANDS B.V**  
EUROPE OFFICE  
Tel: +31(0)180 418 140  
Fax: +31(0)180 418 327  
E-mail: eurosales@csb-battery.eu

**CSB BATTERY LOGISTICS (SHANGHAI) CO., LTD.**  
SHENZHEN OFFICE  
Tel: +86-755-8831-6488/6396/16356  
Fax: +86-755-8831-6548  
E-mail: she@csb-battery.com.cn